

Assembly Instruction

Studio Star Roller Shutter Type R -Manual Drive-

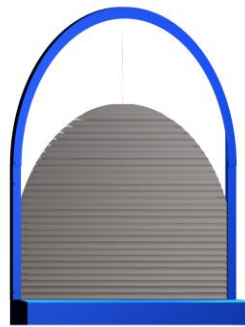

This assembly instruction contains important information on assembling roller shutters as well as important safety instructions.

The assembly operation may only be carried out by specialized staff of Schanz Rollladensysteme GmbH or technicians especially authorized by Schanz Rollladensysteme GmbH.

Schanz Rollladensysteme GmbH

Forchenbusch 9
D- 72226 Simmersfeld
Tel.: +49 (0)7484/9291-0
Fax: +49 (0)7484/9291-36
E-Mail: info@schanz.de
Internet: www.schanz.com



Commission - No.	Date Installation and Instruction	Signature

Content

General Safety Information 2
 Transport / Packaging / Unpacking..... 2
 Assembling / Installation/ Working on the facade..... 2
 Assembly Drawing – Outside Deflection..... 3
 Cord Guidance – Outside Deflection 4
 Description of the basic procedure 5
 Copyright / References to this documentation 12

General Safety Information

This assembly instruction contains information for the correct installation of Schanz roller shutters. Due to the different types deviations may occur from this assembly instruction. However, this does not affect the security information.

Below described assembly steps may only be carried out by specialized staff of Schanz Rollladensysteme GmbH or technicians especially authorized by Schanz Rollladensysteme GmbH.

Adhere to the applicable regulations of the insurance association and take the necessary precautions for all work and consider the safety instructions in this document. Depending on accessibility, scaffoldings, ladders, fall protection devices, lifting devices and Personal Protective Equipment (e.g. safety helmet, safety boots etc.) are to be used.





Transport / Packaging / Unpacking

Depending on the route of transport and the expected conditions the roller shutter will be packed and the roller shutter jacket will be fixed in the roller shutter box. Depending on the type and size of the roller shutters they might be so heavy that a suitable load-carrying equipment and lifting tool has to be utilized.

Only use sufficiently dimensioned, safe and correctly fixated load-carrying equipment and lifting tools and avoid damages and injuries.

Check immediately if the product has been delivered without damage. Immediately complain about damaged roller shutters.

Removing the transportation protection:

Unscrew and open the cover of the roller shutter box	
Remove the foam sheets Caution: The roller shutter jacket could unwind itself due to the initial tension within the drive system!	
Remove entry mouth	
Remove the 4 slats which are connected to the jacket Put on the cover and screw it back	

Assembling / Installation/ Working on the facade

Each roller shutter is individually manufactured according to your window shape and size and must only be installed by Schanz Rollladensysteme GmbH or technicians especially authorized.

	The installation of the roller shutter has to be conducted following the information given in the assembly and safety instructions.
-------------------------------------------------------------------------------------	-------------------------------------------------------------------------------------------------------------------------------------

The installation of the roller shutters should only be conducted on ready-made rainproof facades!

The plastering of the roller shutter could lead to severe damages due to damp and furthermore make essential reparation difficult or even impossible.

	The water drain holes on the bottom of the roller shutter box have to be clear at all times so that ingressed water can drain off! Under no circumstances may the shutter box be buried in the wall or stucco.
-------------------------------------------------------------------------------------	-------------------------------------------------------------------------------------------------------------------------------------------------------------------------------------------------------------------

The roller shutter has to be fixed sufficiently and safe attuned to the ground!

Assembly Drawing – Outside Deflection

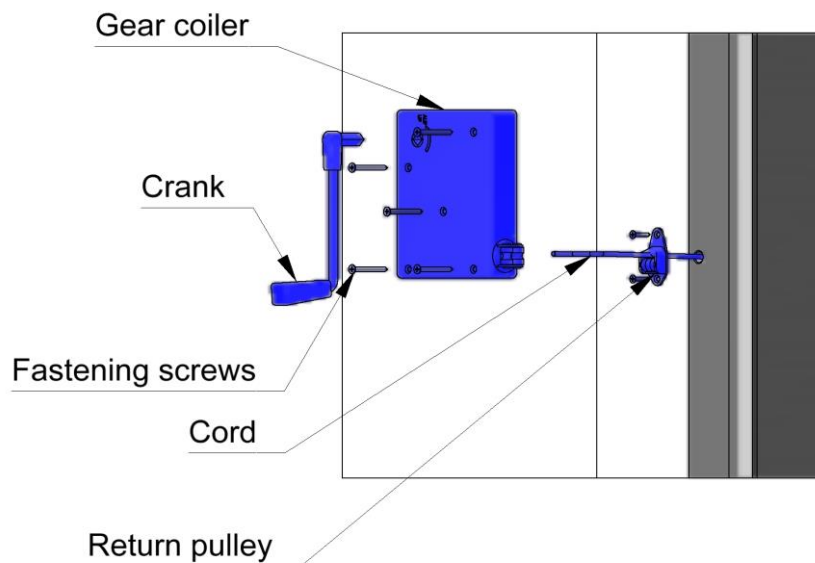
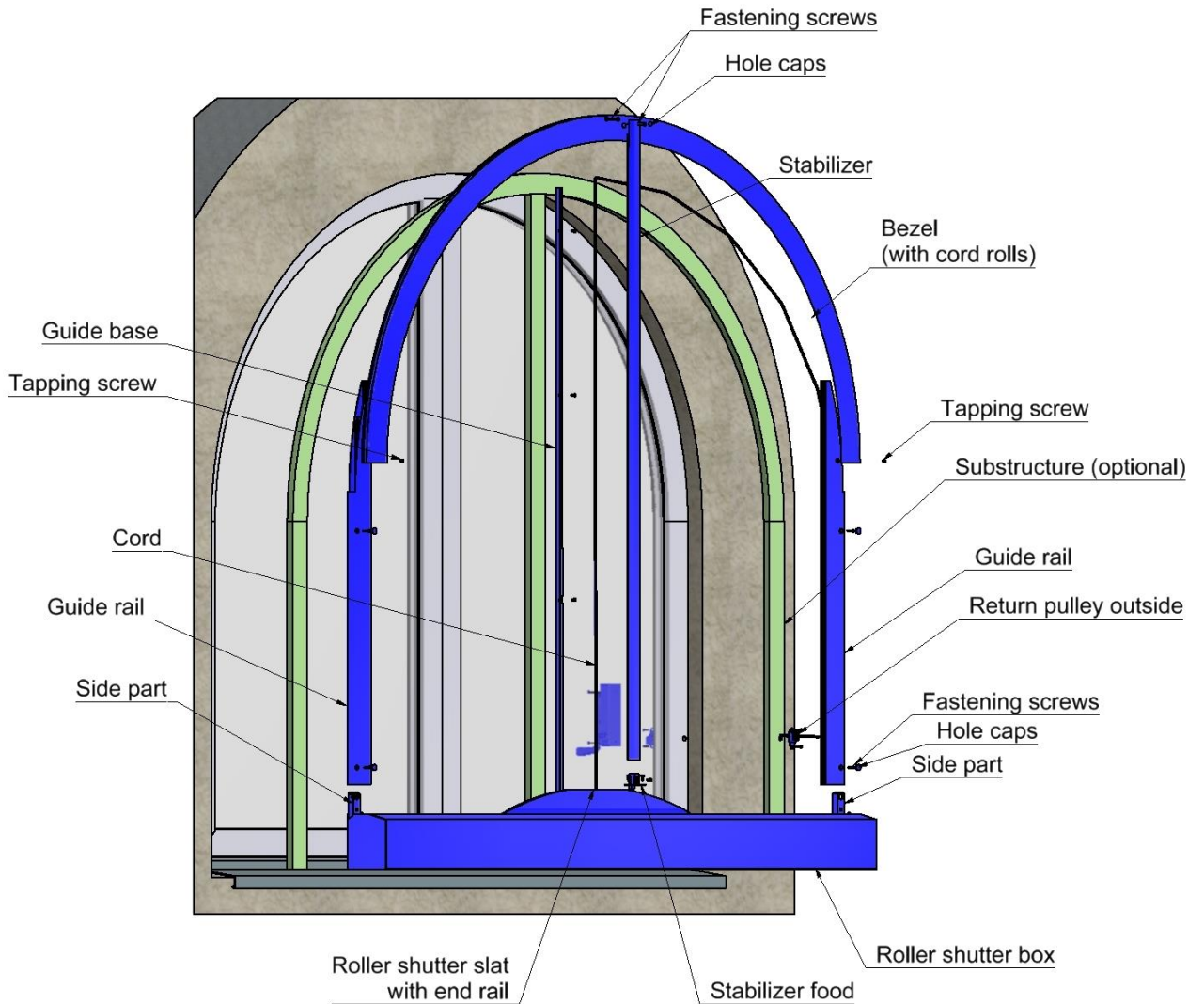

Cord Guidance – Outside Deflection

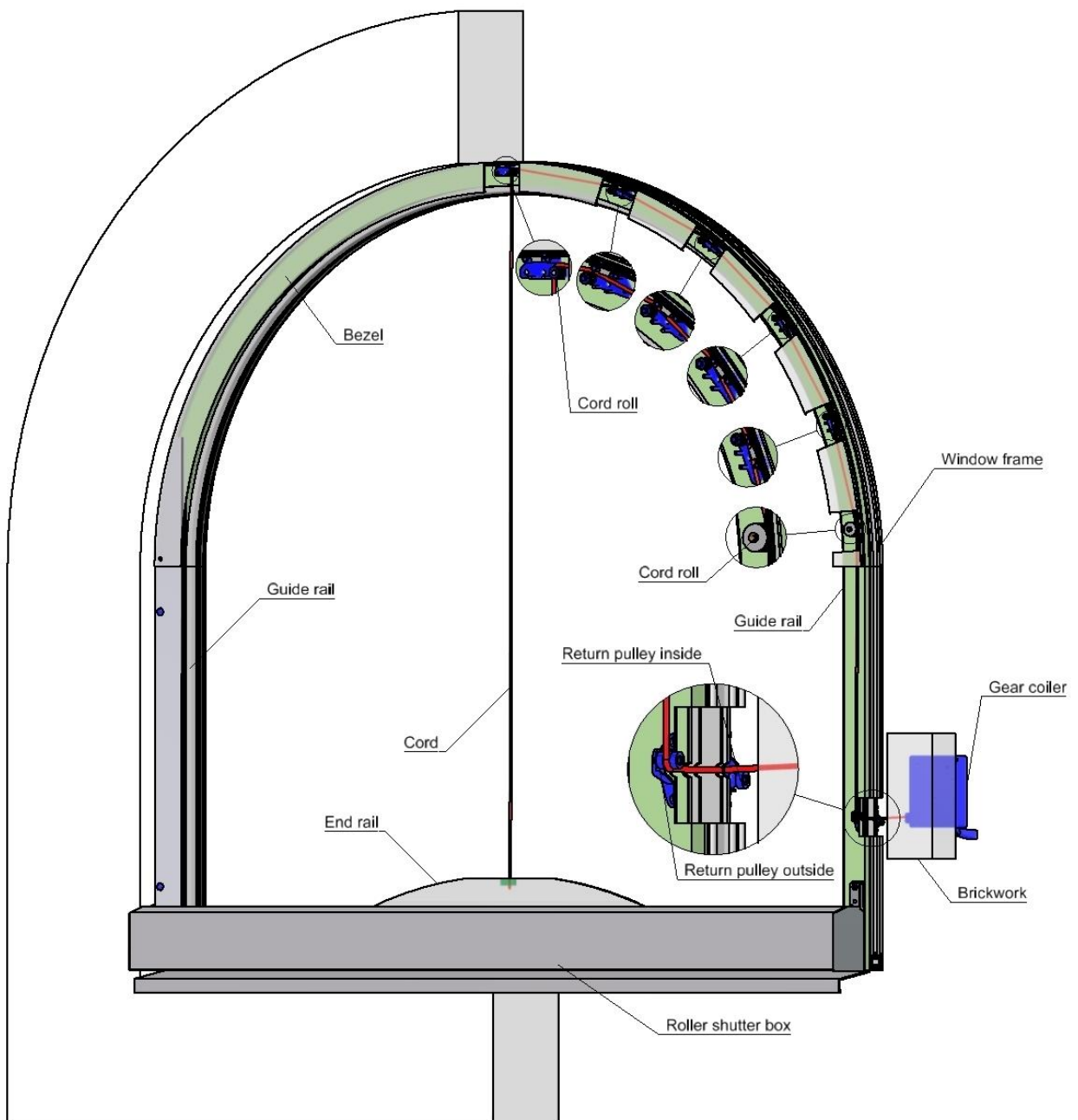

Description of the basic procedure

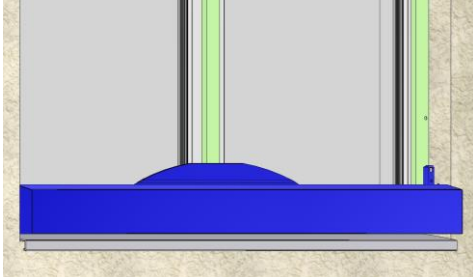
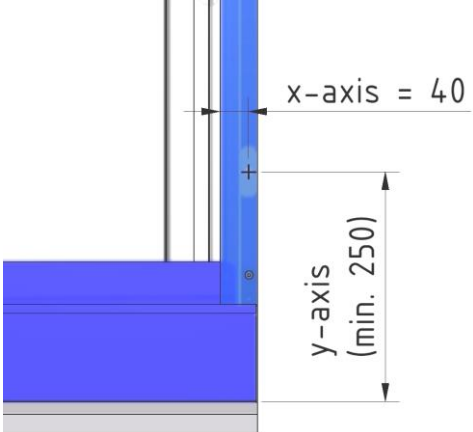
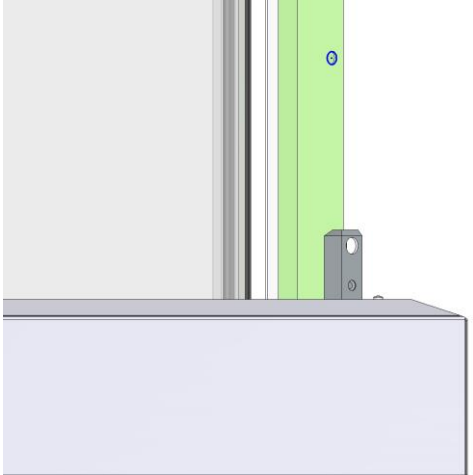
Step No.	Operation	Note	Check
	Check delivery for completeness		<ul style="list-style-type: none"> - Delivery is complete - Compare the goods with delivery note
00	Screw substructure to the window frame with appropriate fixing material	Optional	
10	Align the roller shutter box <ul style="list-style-type: none"> - Put the shutter box on the windowsill - Check if the shutter box mounts horizontally on the windowsill using a spirit level. If necessary underlay the shutter box. The drainage holes on the bottom of the roller shutter must be free so that ingressed water can drain off.		<ul style="list-style-type: none"> - Overlay is necessary
20	Mark the hole for the cord <ul style="list-style-type: none"> - Transmit the value of the y-axis (min. 250 mm) of the bottom edge of the box to the window sill (optional to the substructure) (according to site measurement) - Attach the guide rail and align it - Transmit the value of the x-axis 40 mm of the interior edge to the window frame (optional to the substructure) 		
30	Drill the hole for the cord at the angle of 90° with a drill Ø 12 mm and deburr it		<ul style="list-style-type: none"> - Mind the space on the inside for the installation of the return pulley

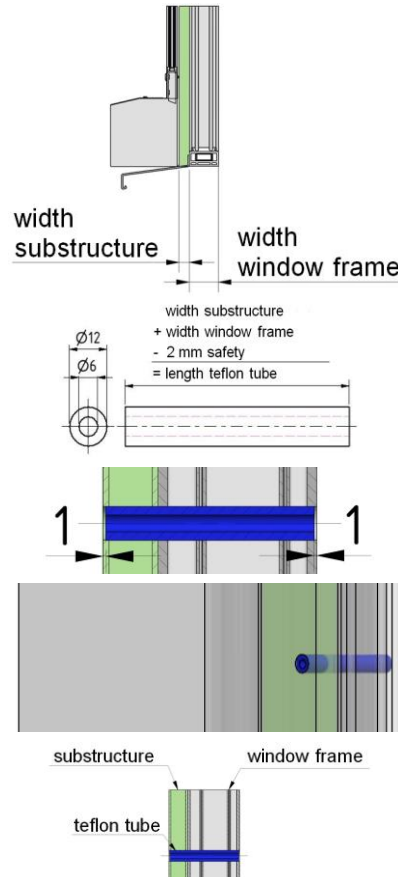
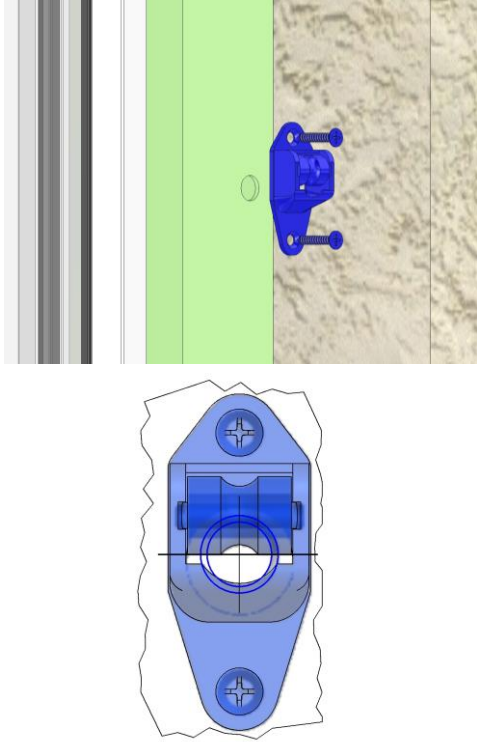
Step No.	Operation	Note	Check
40	<p>Fasten the teflon tube</p> <p>Attention: The teflon tube must be about 2 mm shorter than the length of the through-hole.</p> <p>(substructure and window frame)</p> <p>- Insert the teflon tube into the borehole</p>	 <p>width substructure width window frame</p> <p>width substructure + width window frame - 2 mm safety = length teflon tube</p> <p>Ø12 Ø6</p> <p>substructure window frame</p> <p>teflon tube</p>	<ul style="list-style-type: none"> - The teflon tube about 2 mm shorter than the through-hole - The teflon tube mustn't protrude on both sides
50	<p>Install the outer return pulley</p> <ul style="list-style-type: none"> - Screw the return pulley with appropriate fixing material to the window frame (optional: substructure) 		<ul style="list-style-type: none"> - The course of the cord is in a 90° angle over the return pulley <p>Position:</p> <ul style="list-style-type: none"> - The bottom edge of the reel is mounted centrally to the hole

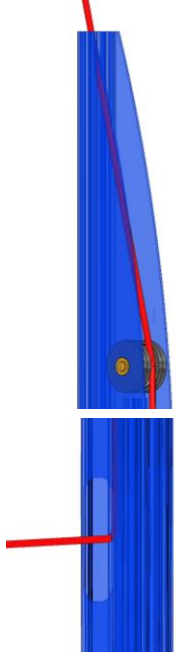
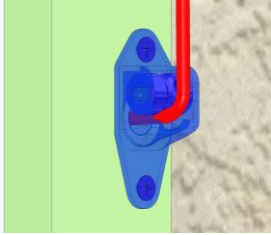
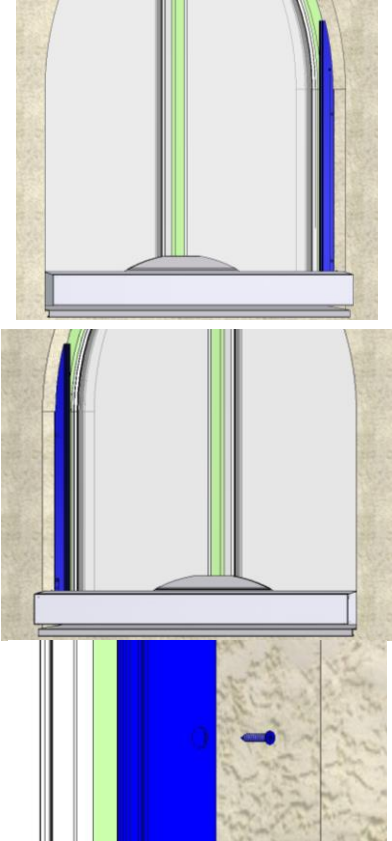
Step No.	Operation	Note	Check
60	Feed the cord into the interior - Pull the cord over the return pulley and through the slot in the guide rail		
	- Pull the cord over the return pulley through the hole into the interior		
70	Attach both guide rails - Put guide rail to the box - Check the correct position using a spirit level - Screw the guide rail with appropriate fixing material and according to the number of fixing holes on the guide rail to the window frame (optional: Substructure)		- Do not damage the cord

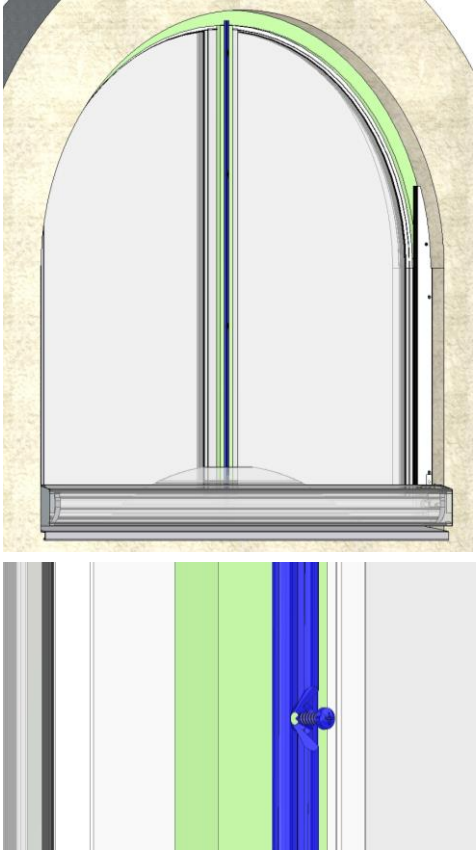
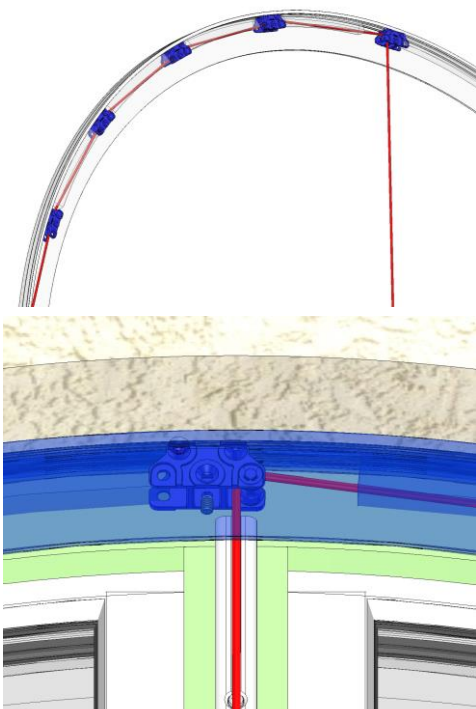
Step No.	Operation	Note	Check
80	<p>Attach Guide base</p> <ul style="list-style-type: none"> - Push the guide base between roller shutter slat and window frame (substructure) onto the bottom of the box and align it. - Screw the guide base with appropriate fixing material and according to the number of fixing holes on the guide rail to the window frame (optional: Substructure) 		
90	<p>Lead the cord through the bezel</p> <ul style="list-style-type: none"> - Lead the cord over the return pulley and put on the bezel. - If necessary adjust the position of the return pulley (unscrew the grub screw beforehand and then tighten it again after correction) 		<ul style="list-style-type: none"> - Position of the cord is perpendicular

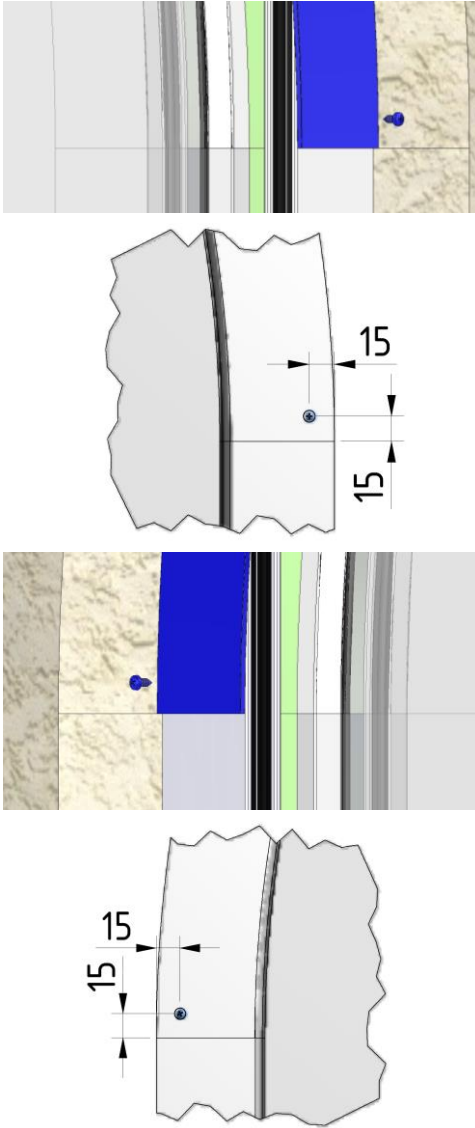
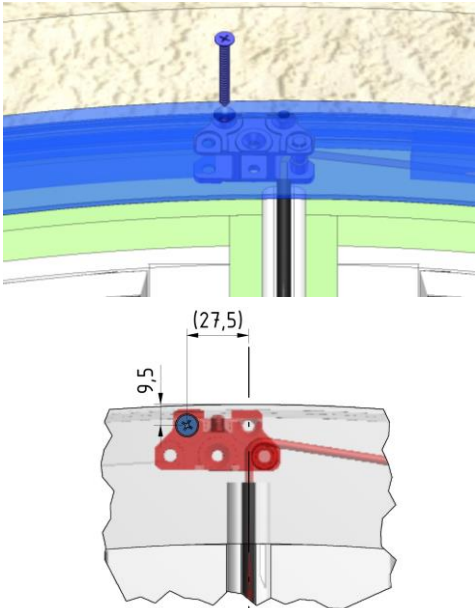
Step No.	Operation	Note	Check
100	<p>Attach the bezels to guide rails</p> <ul style="list-style-type: none"> - Lead the cord over the return pulley in the bezel <ul style="list-style-type: none"> - Attach the bezel and screw it with short tapping screws to the guide rail 		<ul style="list-style-type: none"> - Do not damage the cord
110	<p>Screw together the top bezel</p> <ul style="list-style-type: none"> - Pre-drill a hole for the countersunk screw and lower it, then screw the bezel through the cord roll using appropriate screws, to the window frame (optional substructure). 		<ul style="list-style-type: none"> - Position of the cord is perpendicular - Do not damage the cord - Mind the transmission part below the bezel

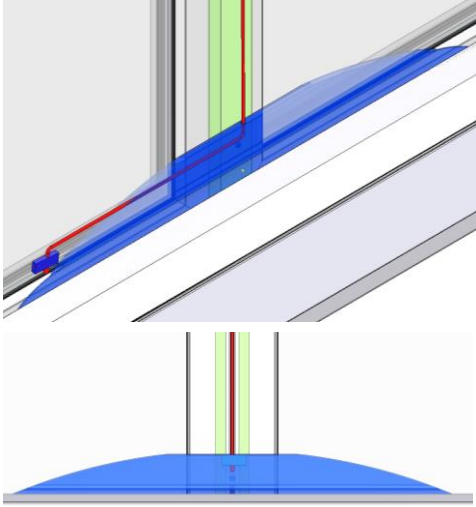
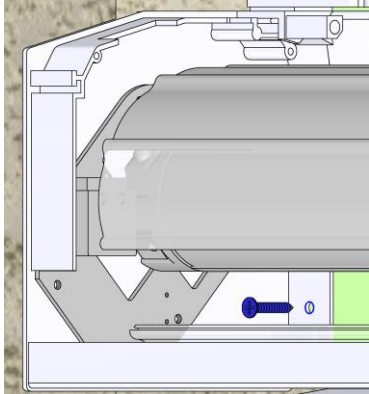
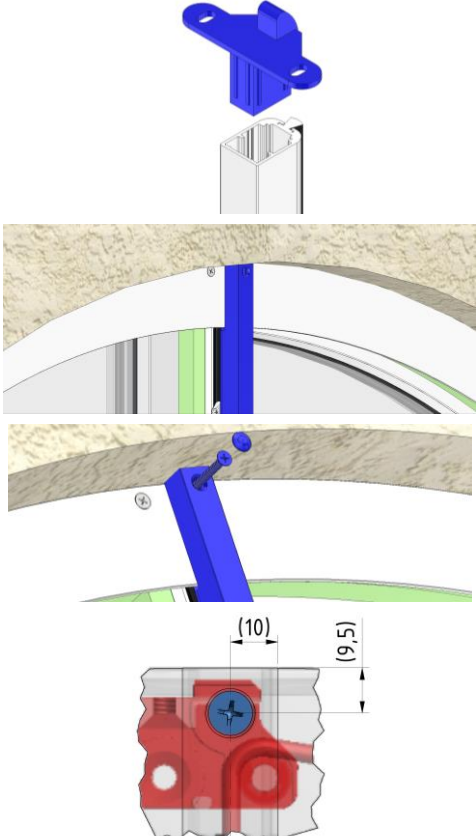
Step No.	Operation	Note	Check
120	<p>Attach the cord</p> <ul style="list-style-type: none"> - Pull the cord end in the end rail and through the end rail inset and knot it together - Overhanging cord should <u>not</u> be cut immediately after the knot – leave it longer for approximately 100mm - Melt the end of the cord with a cigarette lighter <ul style="list-style-type: none"> - Put the end rail inset into the end rail and stow the remaining cord in the end rail. 		<ul style="list-style-type: none"> - Overhanging cord is completely within the end rail
130	<p>Attach Roller shutter box</p> <ul style="list-style-type: none"> - Unscrew the screws of the box lid and open the roller shutter box <ul style="list-style-type: none"> - Screw the roller shutter box on the left and the right side through the side part and back panel with appropriate fixing material to the window frame (optional: substructure) <p>To prevent the box from twisting due to the forces acting, it must be fastened.</p>		<ul style="list-style-type: none"> -
140	<p>Install the stabilizer</p> <ul style="list-style-type: none"> - Put the stabilizer foot into the stabilizer <ul style="list-style-type: none"> - Push the stabilizer with the intended slit on the bezels <ul style="list-style-type: none"> - Pre-drill a hole for the countersunk screw, lower it and then screw together the stabilizer with the bezels using an appropriate screw. <ul style="list-style-type: none"> - Place the hole caps 		<ul style="list-style-type: none"> - Mind the correct position <ul style="list-style-type: none"> - Do not damage the cord - Mind the transmission parts below the bezel

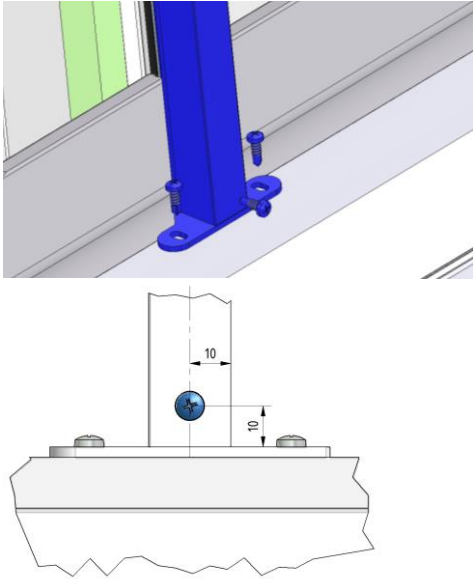
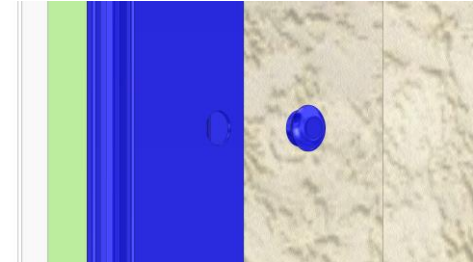
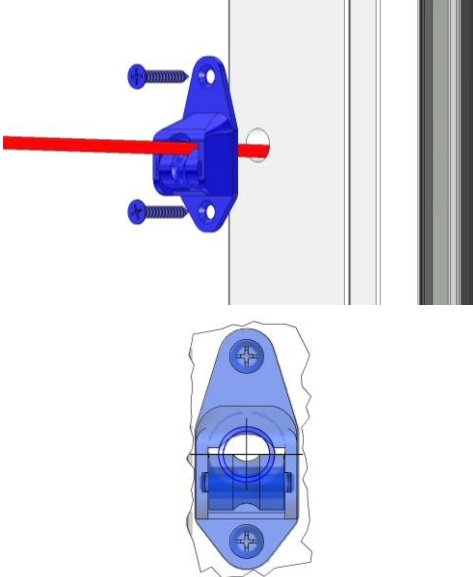
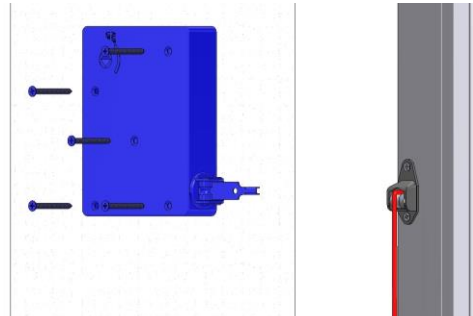
Step No.	Operation	Note	Check
140	<ul style="list-style-type: none"> - Align the stabilizer and screw it with the provided drilling screws to the box - Screw together the stabilizer with the stabilizer foot. 		<ul style="list-style-type: none"> - The end rail of the roller shutter jacket may not be clamped
150	<p>Place the hole caps</p> <ul style="list-style-type: none"> - Place the hole caps according to the amount of anchor points on the guide rail 		<ul style="list-style-type: none"> - The roller shutter is correctly attached and hole caps are available - Water drain holes are clear
160	<p>Install the inner return pulley</p> <ul style="list-style-type: none"> - Pull the cord through the return pulley - Screw the return pulley with appropriate fixing material to the window frame 		<p>Position:</p> <ul style="list-style-type: none"> - The top edge of the reel is mounted centrally to the hole
170	<p>Attach the gearcoil</p> <ul style="list-style-type: none"> - Screw the gearcoil with appropriate fixing material and according to the number of fixing holes to the wall 		<ul style="list-style-type: none"> - Mind an obstacle-free course of the cord and crank

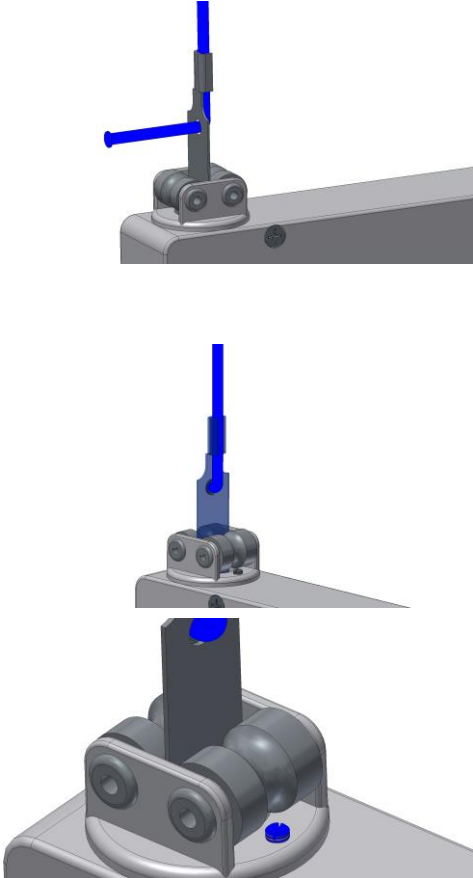
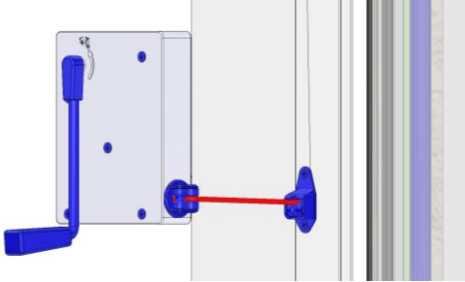
Step No.	Operation	Note	Check
180	<p>Fixing the cord to the gearcoil</p> <ul style="list-style-type: none"> - The length of the cord should be dimensioned in a way that it is reeled up approx. 1m before the roller shutter moves upwards - Pull the cord through the drill hole of the metal strip and melt the end with a cigarette lighter and press the melted end against the metal strip. - Tighten the pull cord along the metal strip and press both flags with a pliers against the cord - If applicable align the deflection on the gear coil to the cord guidance and fix it again with the screw. 		
190	<p>Completion of the installation and test run</p> <ul style="list-style-type: none"> - Tighten the cord and by turning the crank in the UP-direction wind it into the gear coil <p><u>Attention:</u></p> <p>The case should under no circumstances be opened because the spring-assisted self-locking of the gear coil can only be reassembled with special tools.</p> <p>To change an already built in pull cord proceed in reverse order. The metal strip can be pulled out using pliers.</p> <p>Carry out danger and usage instruction with the customer and hand over the provided documentation.</p>		<ul style="list-style-type: none"> - Mind the given direction of rotation of the crank - The roller shutter is correctly attached and hole caps are available - Water drain holes are clear - Roller shutter is working - Instruction took place - Documentation handed over

Copyright / References to this documentation

The copyright (copyright ©) for the present documentation is being kept by Schanz Rollladensysteme GmbH as well as partially by the suppliers of the sub vendor documentation. The containing information is solely designed for the operating companies of our roller shutters. It may not be changed, extended, duplicated, saved on data linked institutions and spread without our written agreement nor should it be used for other purposes. The containing information in this document makes no claim to be complete. We have done everything to reflect the content concerning our products to be correctly and up to date. However a warranty for the correctness of the documentation cannot be given. Especially photographs and other images can contain components which do not belong to the standard scope of delivery (options), or which have been changed in the meantime. Changes in connection with a further development as well as the „state of technology“ are subject to alteration.

Copyright © Schanz Rollladensysteme GmbH, 2023