

# Assembly Instruction

## Studio Star Roller Shutter Type GU -Manual Drive-



This assembly instruction contains important information on assembling roller shutters as well as important safety instructions.

The assembly operation may only be carried out by specialized staff of Schanz Rollladensysteme GmbH or technicians especially authorized by Schanz Rolladensysteme GmbH.

**Schanz Rollladensysteme GmbH**

Forchenbusch 9

D- 72226 Simmersfeld

Tel. +49 (0)7484/9291-0

Fax: +49 (0)7484/ 9291-36

Internet: [www.rollladen.de](http://www.rollladen.de)



Commission - No.	Date Installation and Instruction	Signature

**Content**

General Safety Information.....2  
 Transport / Packaging / Unpacking .....2  
 Assembling / Installation/ Working on the facade.....2  
 Assembly Drawing .....3  
 Belt Guidance .....4  
 Description of the basic procedure .....5  
 Copyright/ References to this documentation .....8

**General Safety Information**

This assembly instruction contains information for the correct installation of Schanz roller shutters. Due to the different types deviations may occur from this assembly instruction. However, this does not affect the security information.

Below described assembly steps may only be carried out by specialized staff of Schanz Rolladensysteme GmbH or technicians especially authorized by Schanz Rolladensysteme GmbH.

Adhere to the applicable regulations of the insurance association and take the necessary precautions for all work and consider the safety instructions in this document. Depending on accessibility, scaffoldings, ladders, fall protection devices, lifting devices and Personal Protective Equipment (e.g. safety helmet, safety boots etc.) is to be used.





**Transport / Packaging / Unpacking**

Depending on the route of transport and the expected conditions the roller shutter will be packed and the roller shutter jacket will be fixed in the roller shutter box. Depending on the type and size of the roller shutters they might be so heavy that a suitable load-carrying equipment and lifting tool has to be utilized.

**Only use sufficiently dimensioned, safe and correctly fixated load-carrying equipment and lifting tools and avoid damages and injuries.**

Check immediately if the product has been delivered without damage. Immediately complain about damaged roller shutters.

Removing the transportation safety devices:

Unscrew and open the cover of the roller shutter box	
Remove the foam sheets <b>Caution:</b> The roller shutter jacket could unwind itself due to the initial tension within the drive system!	
Remove entry mouth	
Remove the 4 slats which are connected to the jacket Put on the cover and screw it back	

**Assembling / Installation/ Working on the facade**

Each roller shutter is individually manufactured according to your window shape and size and must only be installed by Schanz Rolladensysteme GmbH or technicians especially authorized.

	The installation of the roller shutter has to be conducted following the information given in the assembly and safety instructions.
---	---

**The installation of the roller shutters should only be conducted on ready-made rainproof facades!**

The plastering of the roller shutter could lead to severe damages due to damp and furthermore make essential reparation difficult or even impossible.

The roller shutter has to be fixed sufficiently and safe attuned to the ground!

Assembly Drawing

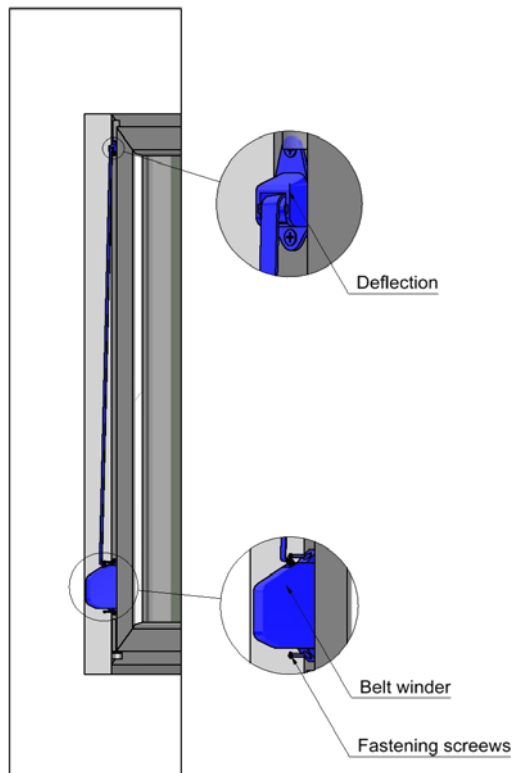
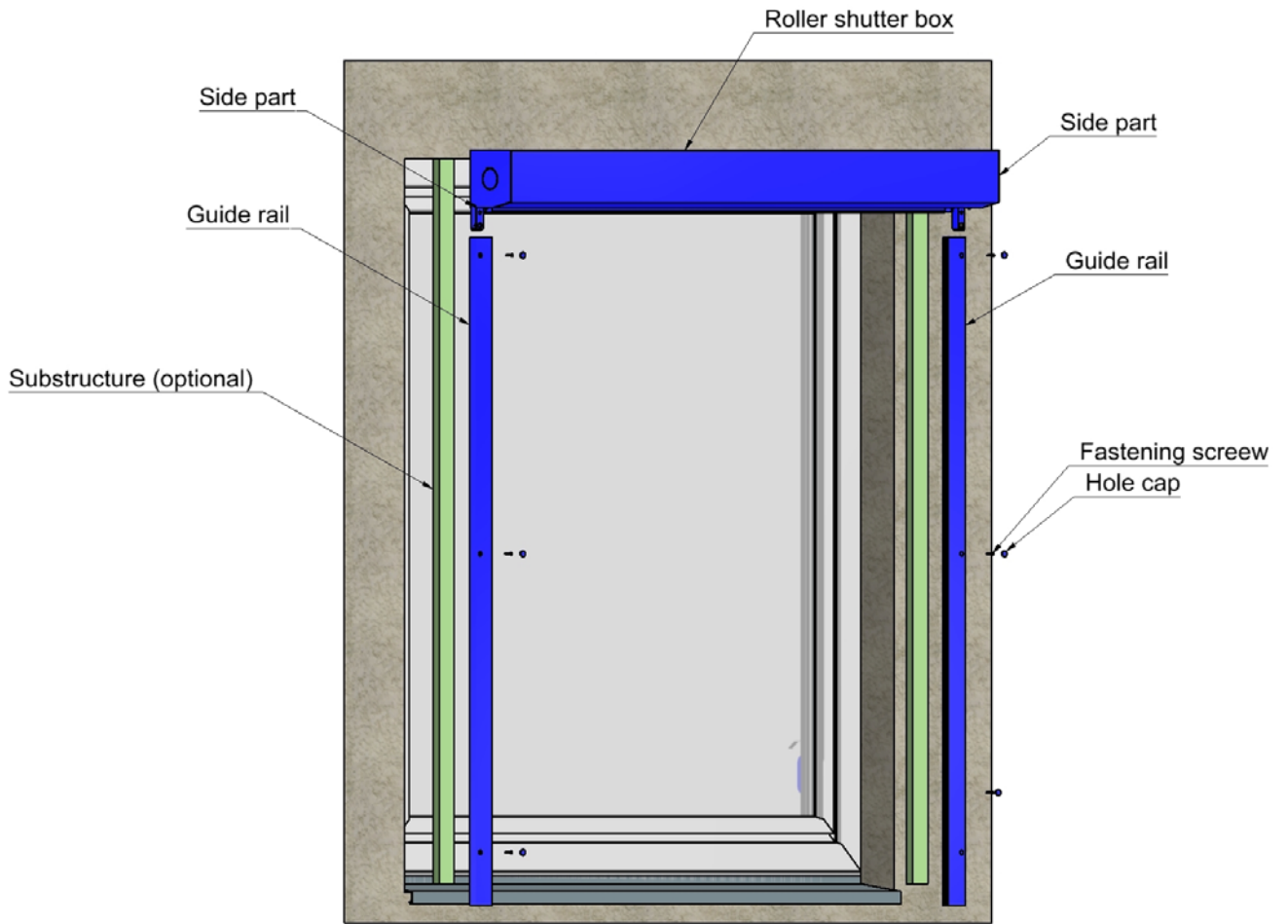

Belt Guidance

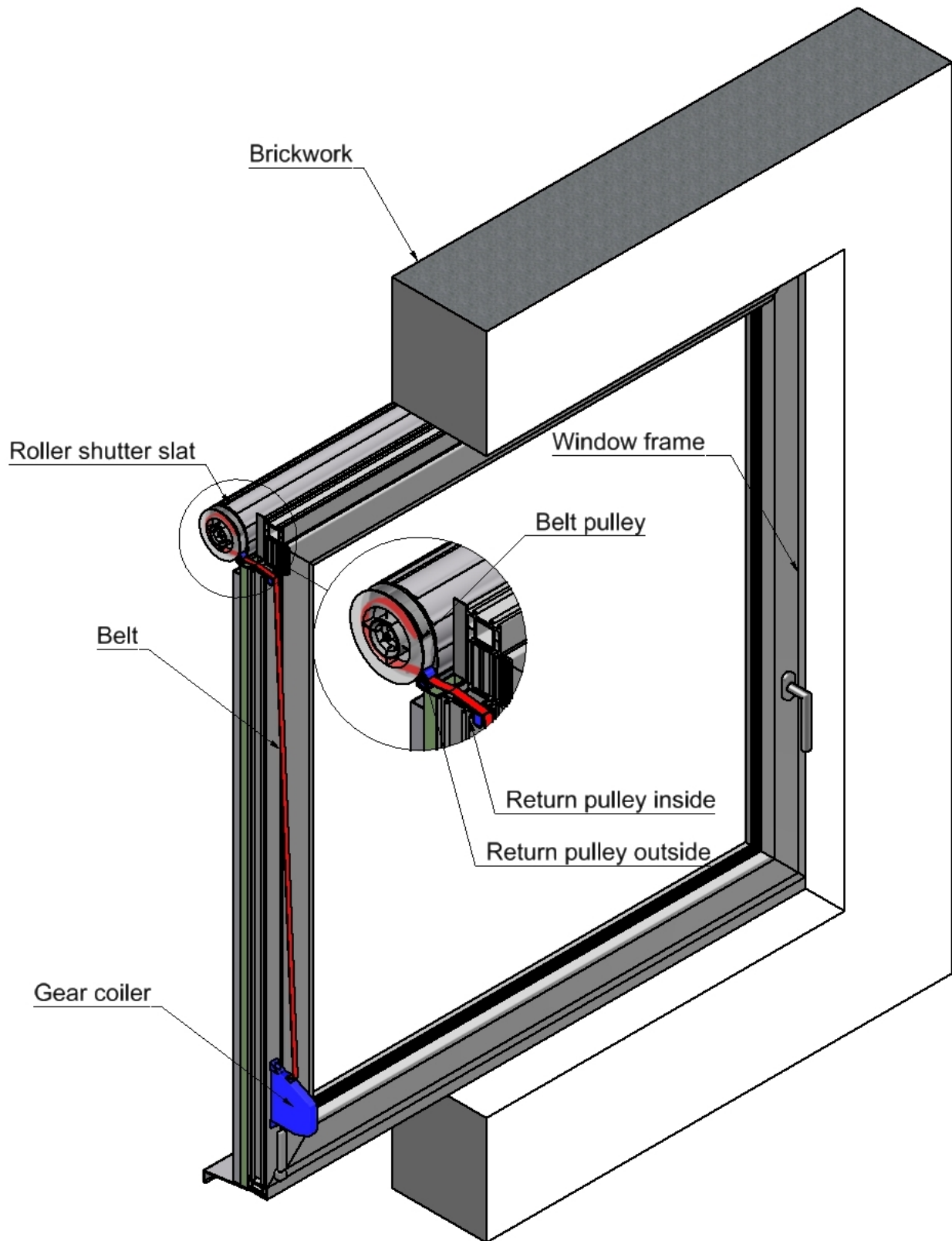

### Description of the basic procedure

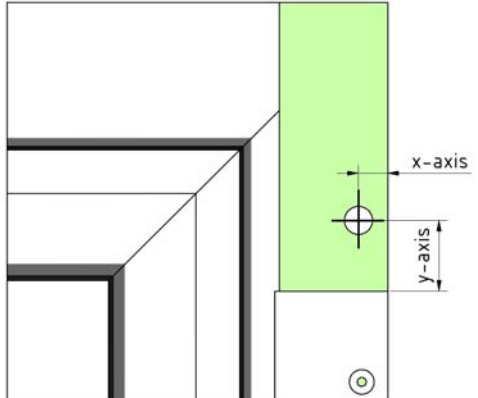
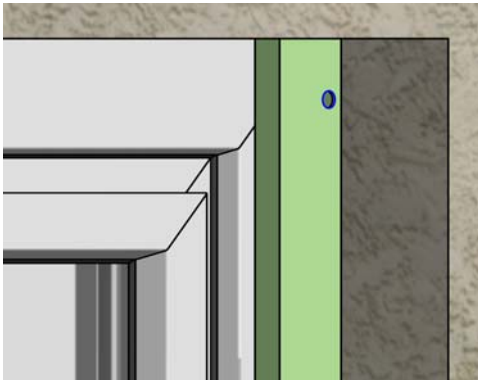
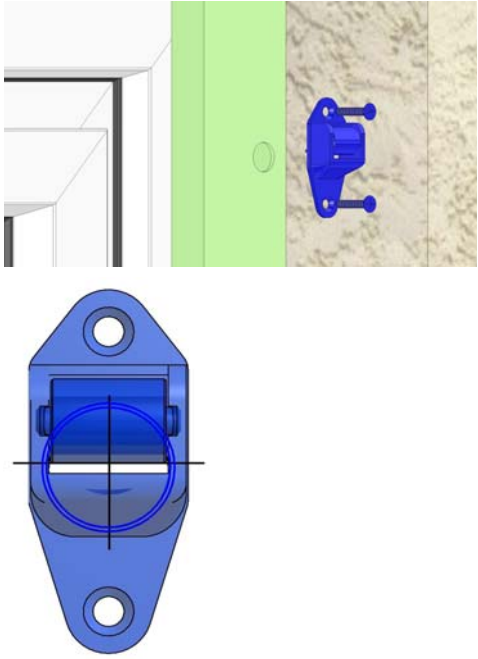
Step No.	Operation	Note	Check
	Check delivery for completeness		<ul style="list-style-type: none"> <li>- Delivery is complete</li> <li>- Compare the goods with delivery note</li> </ul>
00	Screw substructure to the window frame with appropriate fixing material	Optional	
10	Mark the hole for the belt guidance on the window frame (optional to the substructure) Distance to the edges of the guide rails (standard position): x-axis = 13mm y-axis = 35 mm		<ul style="list-style-type: none"> <li>- Correct position of the belt guidance</li> </ul>
20	Drill the hole for the belt at the angle of 90° with a drill Ø 16 mm and deburr it		<ul style="list-style-type: none"> <li>- Mind the space on the inside for the installation of the return pulley</li> </ul>
30	Install the outer return pulley <ul style="list-style-type: none"> <li>- Screw the return pulley with appropriate fixing material to the window frame (optional: substructure)</li> </ul>		<ul style="list-style-type: none"> <li>- The course of the cord is in a 90° angle over the return pulley</li> </ul> <p>Position:</p> <ul style="list-style-type: none"> <li>- The bottom edge of the reel is mounted centrally to the hole</li> </ul>

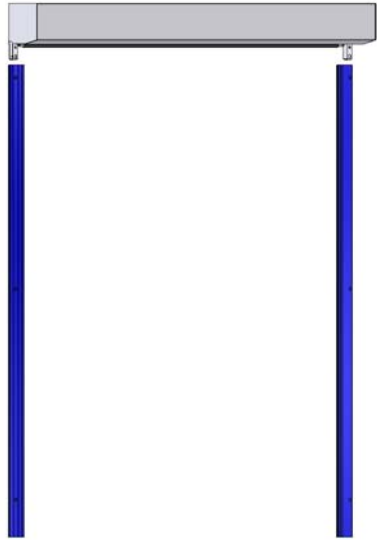
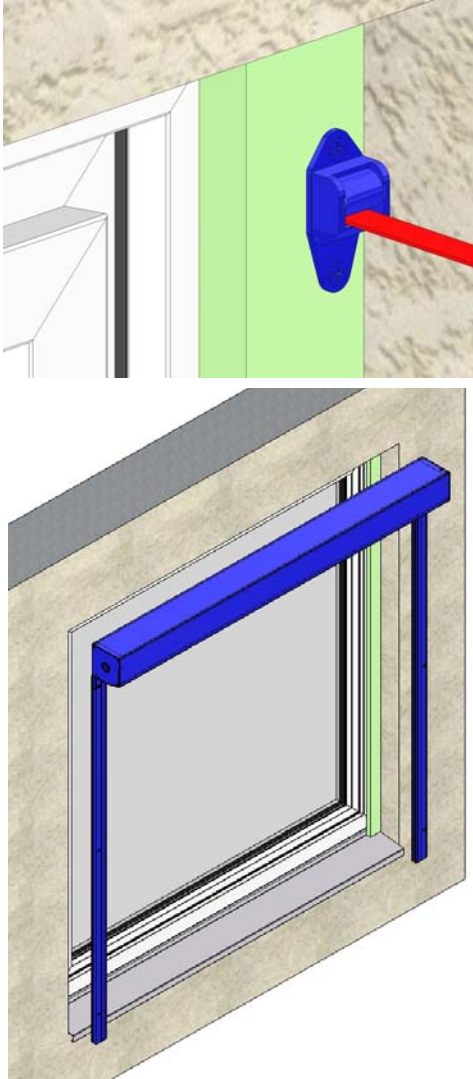
Step No.	Operation	Note	Check
40	Attach both guide rails to the box.		
50	<p>Insert belt and put in the roller shutter</p> <ul style="list-style-type: none"> <li>- Lead the belt over the return pulley through the hole into the interior</li> </ul> <ul style="list-style-type: none"> <li>- Put in the roller shutter</li> <li>- Check if the roller shutter box is in a horizontal position by using a spirit level</li> </ul>		

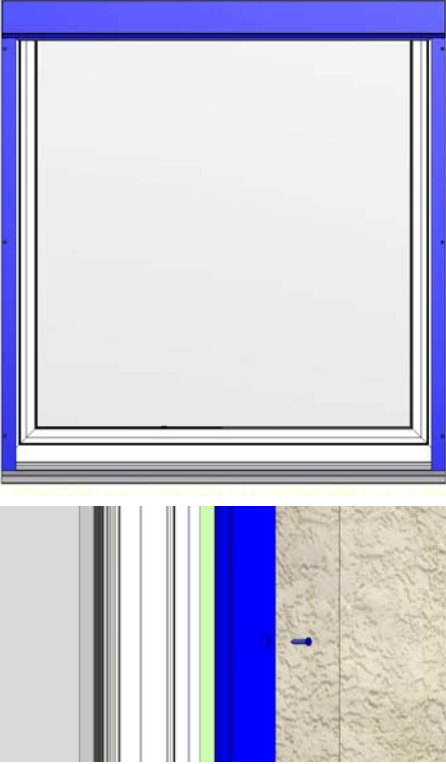
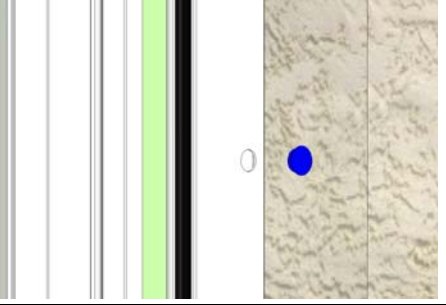
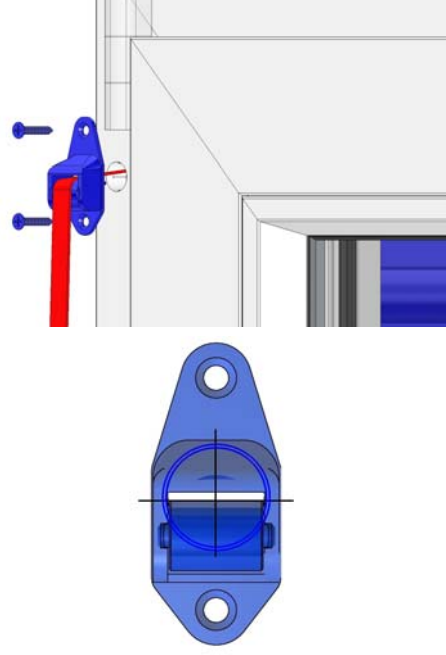
Step No.	Operation	Note	Check
60	<p>Attach both guide rails</p> <ul style="list-style-type: none"> <li>- Check the right position using a spirit level</li> <li>- Screw the guide rails with appropriate fixing material and according to the number of fixing holes on the guide rail to the window frame (optional: Subconstruction)</li> </ul>	 <p>The diagram shows a window frame with two blue guide rails being attached to the top and side. A photograph below shows a close-up of a blue guide rail being secured to a wall with a screw.</p>	
70	<p>Place hole caps</p> <ul style="list-style-type: none"> <li>- Place the hole caps according to the amount of anchor points on the guide rail</li> </ul>	 <p>The photograph shows a close-up of a blue hole cap being inserted into a hole in the white guide rail.</p>	<ul style="list-style-type: none"> <li>- The roller shutter is accurately tight and hole caps are available</li> </ul>
80	<p>Install the inner return pulley</p> <ul style="list-style-type: none"> <li>- Pull the belt through the return pulley</li> <li>- Screw the return pulley with appropriate fixing material to the window frame</li> </ul>	 <p>The diagram shows a blue pulley being mounted to a wall. A photograph below shows a close-up of the pulley being secured with screws. A technical drawing of the pulley is also shown.</p>	<p>Position:</p> <ul style="list-style-type: none"> <li>- The top edge of the reel is mounted centrally to the hole</li> </ul>

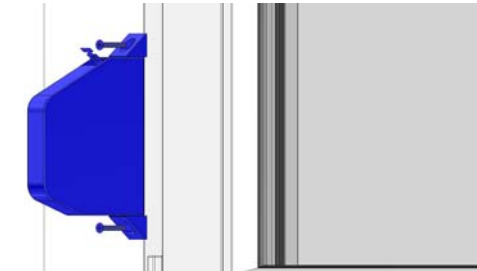
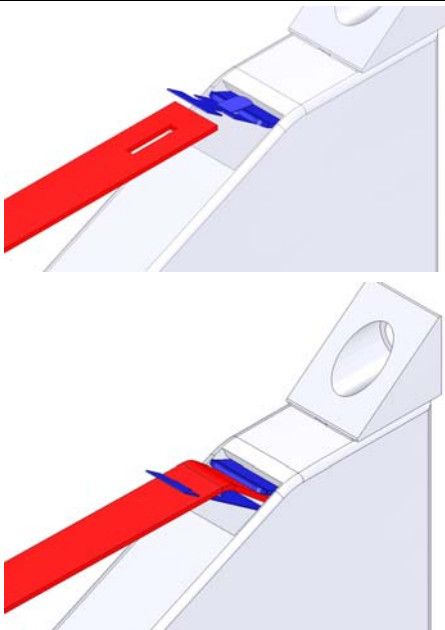
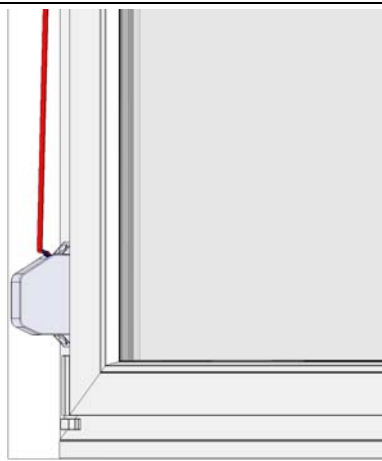
Step No.	Operation	Note	Check
90	<p>Attach the belt winder</p> <ul style="list-style-type: none"> <li>- Screw the belt winder with appropriate fixing material to the window frame or the reveal</li> </ul>		<ul style="list-style-type: none"> <li>- Mind an obstacle-free course of the belt</li> </ul>
100	<p>Fixation of the belt to the gearcoil</p> <ul style="list-style-type: none"> <li>- Fully close the roller shutter unit</li> <li>- Cut the belt approx. 30-40 cm below the belt winder and melt the end with a cigarette lighter</li> <li>- Cut a slit with a length of 1cm into the belt (approx. 1-2 cm of the end)</li> </ul> <ul style="list-style-type: none"> <li>- Put the belt into the winder</li> <li>- Remove safety device Attention: Spring is loaded!</li> <li>- Push the end of the belt under the latch into the winder</li> <li>- Press the latch down und push the belt into the winder, thereby move the latch up and down until the spring pulls up the belt</li> </ul>		<ul style="list-style-type: none"> <li>- Belt is not twisted</li> </ul>
110	<p>Completion of the installation and test run</p> <ul style="list-style-type: none"> <li>- Die Funktion des Rollladens überprüfen</li> </ul> <p><u>Attention:</u></p> <p>The case should under no circumstances be opened, because the spring-assisted self-locking of the gear coil can only be reassembled with special tools.</p> <p>To change an already built in pull cord proceed in reverse order. The metal strip can be pulled out using pliers.</p> <p>Carry out danger and usage instruction with the customer and hand over the provided documentation.</p>		<ul style="list-style-type: none"> <li>- The roller shutter is correctly attached and hole caps are available</li> <li>- Water drain holes are clear</li> <li>- Roller shutter is working</li> <li>- Instruction took place</li> </ul>

#### Copyright/ References to this documentation

The copyright (copyright ©) for the present documentation is being kept by Schanz Rollladensysteme GmbH as well as partially the suppliers of the sub vendor documentation. The containing information is solely designed for the operating companies of our roller shutters. It may not be changed, extended, duplicated, saved on data linked institutions and spread without our written agreement nor should it be used for other purposes. The containing information in this document makes no claim to be complete. We have done everything to reflect the content concerning our products to be correctly and up to date. However a warranty for the correctness of the documentation cannot be given. Especially photographs and other images can contain components which do not belong to the standard scope of delivery (options), or which have been changed in the meantime. Changes in connection with a further development as well as the „state of technology“ are subject to alteration.  
Copyright © Schanz Rollladensysteme GmbH, 2014